

Actual size:
 2.28 x 2.2 x 0.5in
 57,9 x 55,9 x 12,7mm



Filter Input Attenuator Module

Features & Benefits

- RoHS Compliant (with F or G pin style)
- EMI filtering-EN50121-3-2 ^[1]
- Transient protection-EN50155, EN50121-3-2
- Low profile mounting options
- 500W output power
- 60950-1 compliance
- Mini-size package
- Inrush current limiting

Product Highlights

The FIAM072 is a DC front-end module designed for rail applications providing transient protection, inrush current limiting and EMI filtering (EN50121-3-2) in a Mini-size package. The FIAM enables designers using Vicor 72V_{IN} Mini, Micro, or Maxi or VI/VE-200 and VI/VE-J00 (4 input) DC-DC converters to meet the transient immunity and EMI requirements required for the rail industry and protect system hardware from inrush current. The FIAM072 accepts an input voltage of 43 – 110V_{DC} and provide up to 500W of output power and remote on/off control.

The FIAM072 is housed in an industry standard “half brick” module measuring 2.28” x 2.2” x 0.5” and depending upon model selected, may be mounted on-board or in-board for height critical applications.

Compatible Products

- Mini, Micro, Maxi 72V Input DC-DC converters
- VI / VE-200, VI / VE-J00 (“4” input)

^[1] EMI performance is subject to a wide variety of external influences such as PCB construction, circuit layout etc. As such, external components in addition to those listed herein may be required in specific instances to gain full compliance to the standards specified.

Absolute Maximum Rating

Parameter	Rating	Unit	Notes
+IN to –IN	110	V _{DC}	Continuous
	252	V	20ms
+OUT to –OUT	110	V _{DC}	Continuous
Mounting torque	5 (0.57)	in-lbs	6 each, #4-40 or M3
Operating temperature	– 55 to +100	°C	M -Grade
Storage temperature	– 65 to +125	°C	M -Grade
Pin soldering temperature	500 (260)	°F(°C)	<5sec; wave solder
	750 (390)	°F(°C)	<7sec; hand solder

Thermal Resistance

Parameter	Min	Typ	Max	Unit
Baseplate to sink				
	flat, greased surface		0.16	°C/Watt
thermal pad (P/N 20264)		0.14		°C/Watt
Baseplate to ambient				
	Free Convection		8.0	°C/Watt
1000LFM		1.9		°C/Watt

Part Numbering

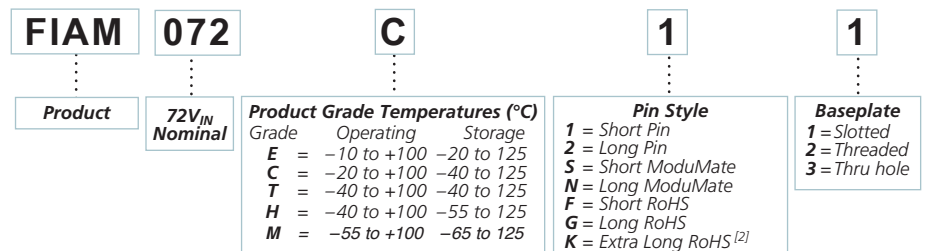

^[2] Not intended for socket or Surfmate mounting

Specifications

(typical at $T_{BP} = 25^{\circ}\text{C}$, nominal line and 75% load, unless otherwise specified)

INPUT SPECIFICATIONS

Parameter	Min	Typ	Max	Unit	Notes
Input voltage	43	72	110	V_{DC}	Continuous
Inrush limiting			0.05	$A/\mu\text{F}$	
Transient immunity			115	V_{DC}	Consistent with 100ms per NF F 01-510
			112.5	V_{DC}	Consistent with 1s per RIA 12
			252	V_{DC}	Consistent with 20ms per RIA 12

OUTPUT SPECIFICATIONS

Parameter	Min	Typ	Max	Unit	Notes
Output power			500	W	Output power derates linearly below $50V_{IN}$ to $400W @ 43V_{IN}$
Efficiency		98		%	
Internal Voltage Drop			1.5	V	500W at 25° baseplate
External capacitance			150	μF	

CONTROL PIN SPECIFICATIONS

Parameter	Min	Typ	Max	Unit	Notes
ON / OFF control					
Enable (ON)	0.0		1.0	V_{DC}	Referenced to $-V_{OUT}$
Disable (OFF)	3.5		5.0	V_{DC}	100k Ω internal pull-up resistor

EMI

Standard	Notes
EN50121-3-2	150kHz to 500kHz - 99dB μV quasi-peak 500kHz to 30MHz - 93dB μV quasi-peak

EMI performance is subject to a wide variety of external influences such as PCB construction, circuit layout etc. As such, external components in addition to those listed herein may be required in specific instances to gain full compliance to the standards specified.

IMMUNITY

Parameter	Typ. Value	Units	Notes
EN50121-3-2 (Table 7.3 Surges)	$\pm 2,000$	V_{DC}	Waveform – 1.2 / 50 μs , 42 Ω , 0.5 μF , line to ground
	$\pm 1,000$	V_{DC}	Waveform – 1.2 / 50 μs , 42 Ω , 0.5 μF , line to line Performance Criteria B - no damage to the product but a temporary change in the intended DC voltage is acceptable as long as it self-recovers without user intervention.
EN50121-3-2 (Table 7.2 Fast Transients)	$\pm 2,000$	V_{DC}	5/50ns, 5kHz Performance Criteria A - no damage to the product and no change to the intended DC voltage level for a duration greater than 1.0 μsec .
EN50121-3-2 (Table 7.1 RF Common Mode)			0.15 to 80MHz, 10 V_{RMS} , 80% AM, 1kHz Performance Criteria A - no damage to the product and no change to the intended DC voltage level greater than +/-5%.

SAFETY SPECIFICATIONS

Parameter	Min	Typ	Max	Unit	Notes
Dielectric withstand (I/O to baseplate)		1,000		V_{RMS}	
		1,414		V_{DC}	

Specifications (Cont.)

AGENCY APPROVALS

Safety Standards	Markings	Notes
UL60950-1, CSA60950-1, EN60950-1, IEC60950-1 EN60950-1	cTUVus CE	Pending Low Voltage Directive

GENERAL SPECIFICATIONS

Parameter	Min	Typ	Max	Unit	Remarks
Weight		3.1 (88)	4 (113)	ounces (grams)	
Warranty			2	years	

MODULE ENVIRONMENTAL QUALIFICATION

Altitude MIL-STD-810F, Method 500.4, Procedure I & II, 40,000ft. and 70,000ft. Operational.
Explosive Atmosphere MIL-STD-810F, Method 511.4, Procedure I, Operational.
Vibration EN 61373, Random Vibration: Category <0.3Kg, Freq range: 5-150Hz @ 5grms, 5hrs per axis. MIL-STD-810F, Method 514.5, Procedure I, Category 14, Sine and Random vibration per Table 514.5C for Helicopter AH-6J Main Rotor with overall level of 5.6Grms for 4 hours per axis. MIL-STD-810F, Method 514.5C, General Minimum Integrity Curve per Figure 514.5C-17 with overall level of 7.7Grms for 1 hour per axis.
Shock EN 61373, Shock: Long. / Trans. / Vert. Axis, peak acceleration: 5g / 2g / 1g, Duration: 50ms/ 20ms. MIL-STD-810F, Method 516.5, Procedure I, Functional Shock, 40g. MIL-S-901D, Lightweight Hammer Shock, 3 impacts/axis, 1,3,5 ft. MIL-STD-202F, Method 213B, 60g, 9ms half sine. MIL-STD-202F, Method 213B, 75g, 11ms Saw Tooth Shock.
Acceleration MIL-STD-810F, Method 513.5, Procedure II, table 513.5-II, Operational, 2-7g, 6 directions.
Humidity MIL-STD-810F, Method 507.4.
Solder Test MIL-STD-202G, Method 208H, 8 hour aging.

MODULE ENVIRONMENTAL STRESS SCREENING

Parameter	H-Grade	M-Grade
Operating temperature	-40°C to +100°C	-55°C to +100°C
Storage temperature	-55°C to +125°C	-65°C to +125°C
Temperature cycling*	12 cycles -65°C to +100°C	12 cycles -65°C to +100°C
Ambient test @ 25°C	Yes	Yes
Power cycling burn-in	12 hours, 29 cycles	24 hours, 58 cycles
Functional and parametric ATE tests	-40°C and +100°C	-55°C and +100°C
Hi-Pot test	Yes	Yes
Visual inspection	Yes	Yes
Test data	vicorpower.com	vicorpower.com

*Temperature cycled with power off, 17°C per minute rate of change.

Conducted Noise

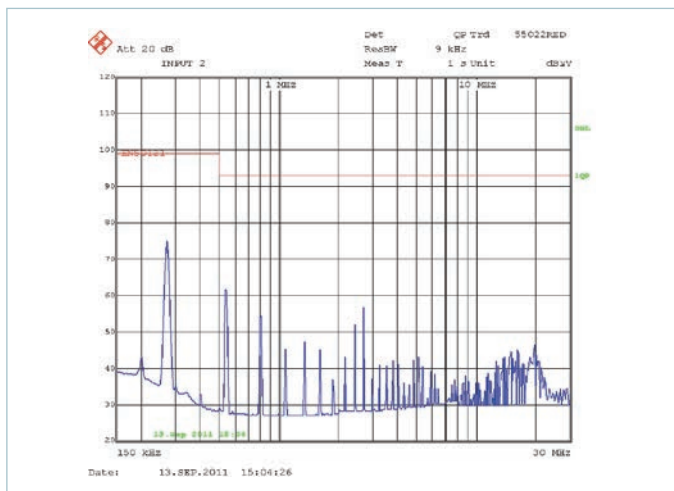

Figure 1 — Conducted Noise (EN50121-3-2); FIAM72M21 and model V72A24C400BL DC-DC converter operating at 72V_{DC} 375

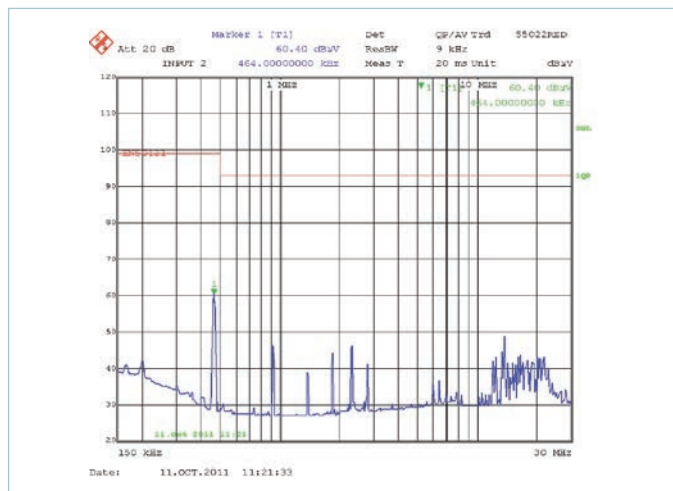

Figure 2 — Conducted Noise (EN50121-3-2); FIAM72M21 and model VE-243-EU + VI-B43-CU DC-DC converters operating at 72V_{DC} 375W

Insertion Loss

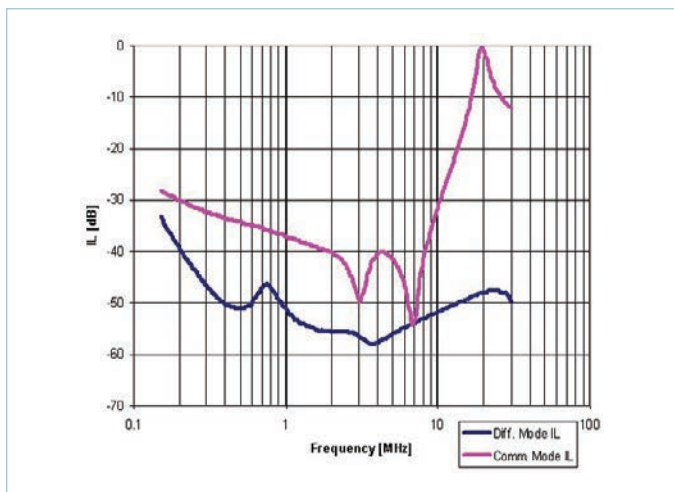

Figure 3 — Insertion loss curve

Inrush Limiting

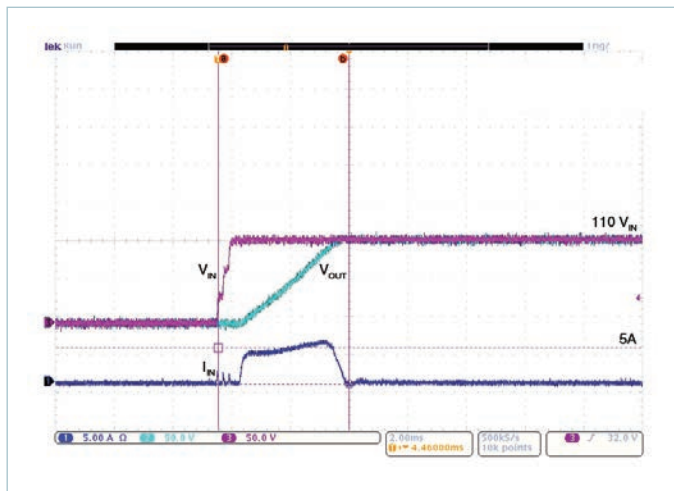

Figure 5 — Inrush current. (150μF external capacitance)

Transient Immunity

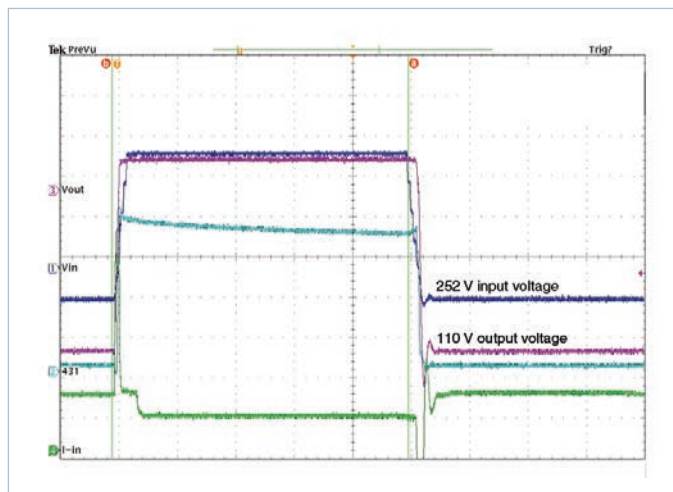

Figure 4 — Transient Immunity: FIAM output response to an input transient

Transient and Surge Protection

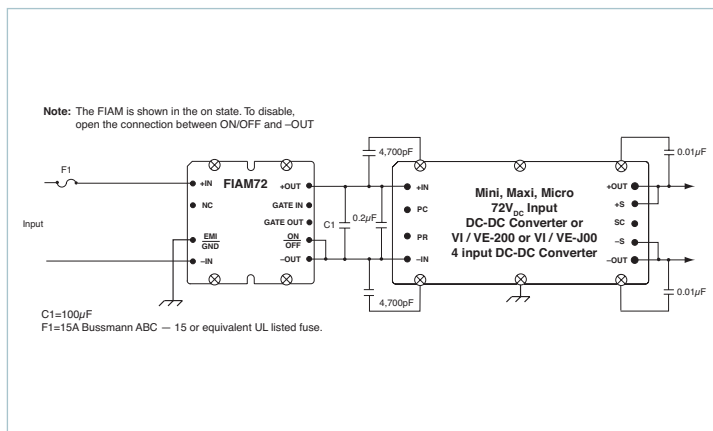
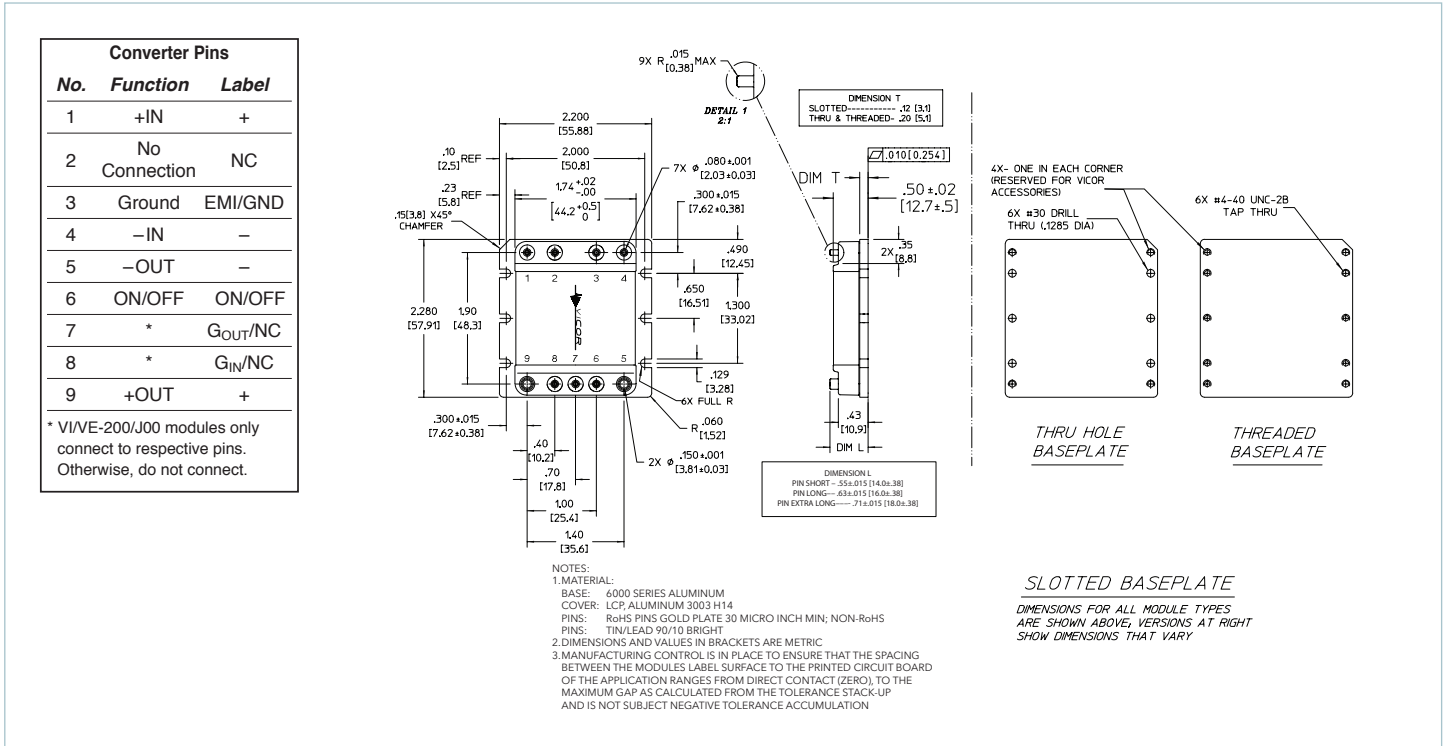

Figure 6 — Typical connection diagram

Storage

Vicor products, when not installed in customer units, should be stored in ESD safe packaging in accordance with ANSI/ESD S20.20, "Protection of Electrical and Electronic Parts, Assemblies and Equipment" and should be maintained in a temperature controlled factory/warehouse environment not exposed to outside elements controlled between the temperature ranges of 15°C and 38°C. Humidity shall not be condensing, no minimum humidity when stored in an ESD compliant package.

Mechanical Diagram



PCB Mounting Specifications

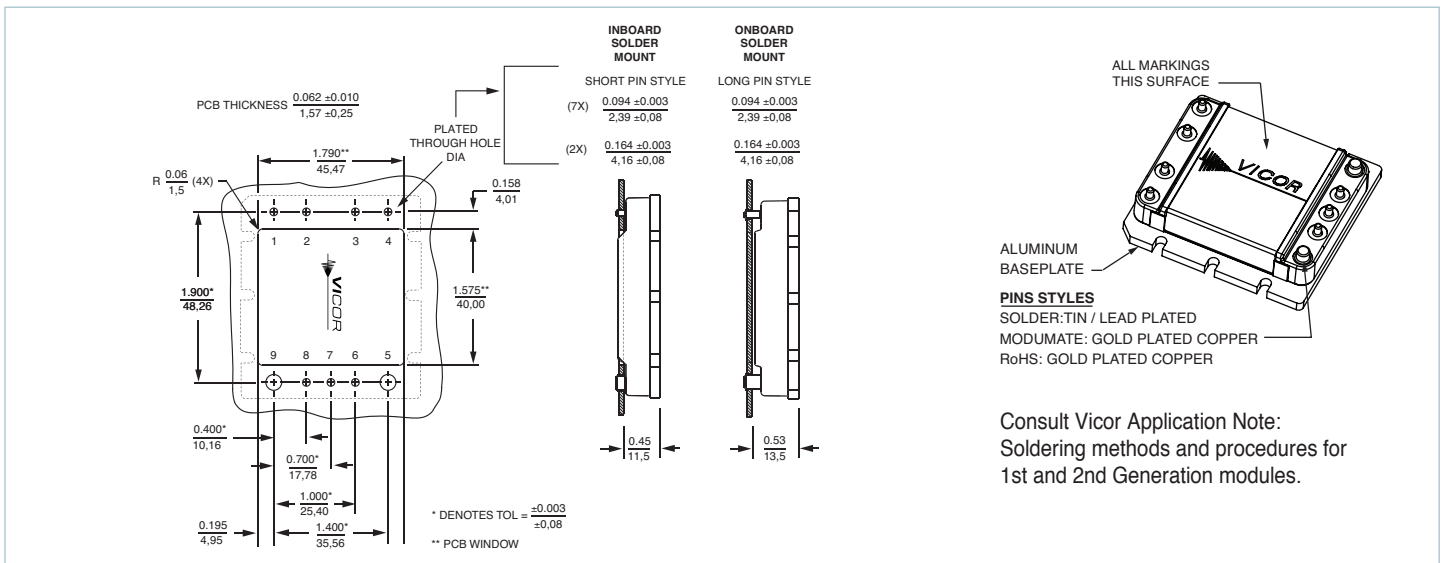

Vicor's comprehensive line of power solutions includes high density AC-DC and DC-DC modules and accessory components, fully configurable AC-DC and DC-DC power supplies, and complete custom power systems.

Information furnished by Vicor is believed to be accurate and reliable. However, no responsibility is assumed by Vicor for its use. Vicor makes no representations or warranties with respect to the accuracy or completeness of the contents of this publication. Vicor reserves the right to make changes to any products, specifications, and product descriptions at any time without notice. Information published by Vicor has been checked and is believed to be accurate at the time it was printed; however, Vicor assumes no responsibility for inaccuracies. Testing and other quality controls are used to the extent Vicor deems necessary to support Vicor's product warranty. Except where mandated by government requirements, testing of all parameters of each product is not necessarily performed.

Specifications are subject to change without notice.

Visit http://www.vicorpower.com/dc-dc_filters/fiam-filter_input_attenuator_module for the latest product information.

Vicor's Standard Terms and Conditions and Product Warranty

All sales are subject to Vicor's Standard Terms and Conditions of Sale, and Product Warranty which are available on Vicor's webpage (<http://www.vicorpower.com/termsconditionswarranty>) or upon request.

Life Support Policy

VICOR'S PRODUCTS ARE NOT AUTHORIZED FOR USE AS CRITICAL COMPONENTS IN LIFE SUPPORT DEVICES OR SYSTEMS WITHOUT THE EXPRESS PRIOR WRITTEN APPROVAL OF THE CHIEF EXECUTIVE OFFICER AND GENERAL COUNSEL OF VICOR CORPORATION. As used herein, life support devices or systems are devices which (a) are intended for surgical implant into the body, or (b) support or sustain life and whose failure to perform when properly used in accordance with instructions for use provided in the labeling can be reasonably expected to result in a significant injury to the user. A critical component is any component in a life support device or system whose failure to perform can be reasonably expected to cause the failure of the life support device or system or to affect its safety or effectiveness. Per Vicor Terms and Conditions of Sale, the user of Vicor products and components in life support applications assumes all risks of such use and indemnifies Vicor against all liability and damages.

Intellectual Property Notice

Vicor and its subsidiaries own Intellectual Property (including issued U.S. and Foreign Patents and pending patent applications) relating to the products described in this data sheet. No license, whether express, implied, or arising by estoppel or otherwise, to any intellectual property rights is granted by this document. Interested parties should contact Vicor's Intellectual Property Department.

Vicor Corporation

25 Frontage Road
Andover, MA, USA 01810
Tel: 800-735-6200
Fax: 978-475-6715

email

Customer Service: custserv@vicorpower.com
Technical Support: apps@vicorpower.com